

MARINE THERMOSTAT HOUSINGS









MERCURISER "DESIGN ONE" THERMOSTAT HOUSING



MERCURISER THERMOSTAT HOUSING FOR 1983 THRU 1993 CENTER RISER STYLE MANIFOLD "DESIGN ONE"









BJMMERCSBTHK - KIT

5.0 & 5.7 Liter Small Block Engines

	1	Part# OSCMC55-TSB	Description (1) Top Cover
	2	18-2554	(2) Gasket
	3	18-3551 18-3649	(3) Thermostat 143° *Thermostat 160°
	4	18-2553	(4) Gasket
	5	2347508T	(5) Sleeve
	6	18-1994	(6) Lower Housing w/ "T" valve & check balls
	8	2298477A2	(8) "T" valve w/ check balls
	7	18-2917	(7) Gasket w/ grounding contacts

BJMMERCBTHK - KIT

7.4 Liter (I.O) Big Block Engines

	1	Part# OSCMC55-TBB	Description (1) Top Cover
	2	18-2554	(2) Gasket
	3	18-3551 18-3649	(3) Thermostat 143° *Thermostat 160°
	4	18-2553	(4) Gasket
	5	2347508T	(5) Sleeve
	6	OSCMC552-BB	(6) Lower Housing order "T" valve separate, if needed
	8	2298477A2	(8) "T" valve w/ check balls
	7	18-2917	(7) Gasket w/ grounding contacts



Part#
18-3651
Description:
143° Thermostat
& gasket kit

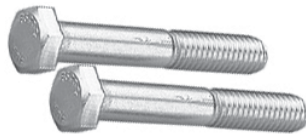

Part#
FAS1060410

Description:
3/8-16 X 4-1/4 s/s
Mounting bolts



Part#
BJM91121

Description:
3/8" s/s lock washer



CAST IRON THERMOSTAT HOUSING



Part# 18-3530

Description:
Design #3, fits 4.3 & 5.7L
Mercuriser engines
(will not fit 7.4L)



STAINLESS STEEL THERMOSTAT HOUSING



Part# 18-1989

Description:
Design #3, fits 4.3, 5.7 & 7.4L
mercuriser engines (note: engine
lifting ring cannot be reinstalled
with this housing)



Part# 23806922

Description:
Thermostat housing
sleeve for #18-1989



Part# 18-3648

Description:
Thermostat kit, contains
(18-3649) thermostat 160°
(27806871) cork gasket
(18-2917) cover gasket





MARINE THERMOSTAT HOUSINGS

MERCUISER "DESIGN TWO" THERMOSTAT HOUSING















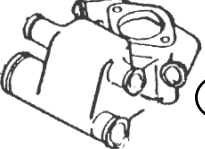

MERCUISER THERMOSTAT HOUSING "DESIGN TWO"



MerCruiser 5.0 & 5.7 Liter
Small Block engines

MerCruiser 7.4 Liter (I.O.)
Big Block engines

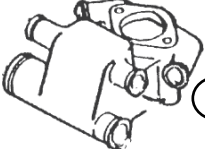
- | | | | |
|-------------------------------------------------------------------------------------|----------|-------------------------|----------------------------------------------------------|
|  | 1 | Part#
17494A1 | Description
(1) Top cover |
|  | 2 | 18-2552 | (2) Gasket |
|  | 3 | 23806922 | (3) Sleeve |
|  | 4 | 18-3551 | (4) Thermostat 143° |
|  | 5 | 18-7173 | (5) O-ring |
|  | 6 | **see note below** | (6) "NLA" |
|  | 7 | 18-2917 | (7) Gasket w/
grounding contacts |
|  | 8 | 18-3668 | (8) Thermostat & gasket kit,
contains (2), (4), & (5) |

- | | | | |
|--------------------------------------------------------------------------------------|----------|-------------------------|----------------------------------------------------------|
|  | 1 | Part#
17494A1 | Description
(1) Top cover |
|  | 2 | 18-2552 | (2) Gasket |
|  | 3 | 23806922 | (3) Sleeve |
|  | 4 | 18-3551 | (4) Thermostat 143° |
|  | 5 | 18-7173 | (5) O-ring |
|  | 6 | **see note below** | (6) "NLA" |
|  | 7 | 18-2917 | (7) Gasket w/
grounding contacts |
|  | 8 | 18-3668 | (8) Thermostat & gasket kit,
contains (2), (4), & (5) |

*Note: MerCruiser discontinued these Design Two thermostat housings, for a replacement housing for the 5.0 & 5.7 liter small block use kit # **BJMMERCSBTHK**

*Note: MerCruiser discontinued these Design Two thermostat housings, for a replacement housing for the 7.4 liter (I.O.) big block use kit # **BJMMERCBTHK**



MERCURY (FWC) THERMOSTAT HOUSING SB & BB



- | | | | |
|-------------------------------------------------------------------------------------|----------|-------------------------------------------------------------------------------------|----------|
|  | 1 | | |
|  | 2 |  | 5 |
|  | 3 |  | 6 |
|  | 4 |  | 7 |

Ref#	Part#	Description:
1	OSCMC55-TSB	SB Top cover
*1	OSCMC55-TBB	BB Top cover
2	18-2844	Gasket
3	OSC47508	Sleeve
4	18-2553	Cork O-ring
5	18-3551	Thermostat 143°
*5	CRU97895	Thermostat 160°
6	55131A5	Lower Housing
7	18-2917	Gasket w/ grounding contacts

MARINE THERMOSTAT HOUSINGS

MERCUISER THERMOSTAT HOUSINGS



MERCUISER THERMOSTAT HOUSINGS

GM V8 305-350

Small Block Engines w/ Log style or End riser manifolds



1 Part#
OSCMC55-TSB Description
(1) Top cover



2 **18-3551** (2) Thermostat
143° R/W cooling



3 **18-2844** (3) Gasket



4 **OSCMC553-SB** (4) Lower housing



5 **18-2917** (5) Gasket w/
grounding contacts

GM V8 454

Big Block Engines w/ Log style or End riser manifolds



1 Part#
OSCMC55-TBB Description
(1) Top cover



2 **18-3551** (2) Thermostat
143° R/W cooling



3 **18-2844** (3) Gasket



4 **OSCMC553-BB** (4) Lower housing



5 **18-2917** (5) Gasket w/
grounding contacts



MERCUISER THERMOSTAT HOUSINGS

MerCruiser 120, 140, 120R/140R, 160, 165, 200 4 & 6 cyl. In-line engines



1 Part#
MC-29-60372 Description
(1) Top cover



2 **18-2831** (2) Gasket



3 **18-3550** (3) Thermostat 140°



4 **MC-29-47587** (4) Lower housing



5 **18-0164** (5) Gasket



6 **18-3650** (6) Thermostat kit

MerCruiser 888, 225 (Ford), 233, (Ford), 255 (Ford) engines



1 Part#
MC-29-62898 Description
(1) Top cover



2 **18-2834** (2) Gasket



3 **18-3551** (3) Thermostat 143°



4 **MC-29-63588** (4) Lower housing



5 **18-0349** (5) Gasket



MARINE THERMOSTAT HOUSINGS

CRUSADER, FORD, & OMC THERMOSTAT HOUSINGS

CRUSADER (SWC) & (FWC) THERMOSTAT HOUSING

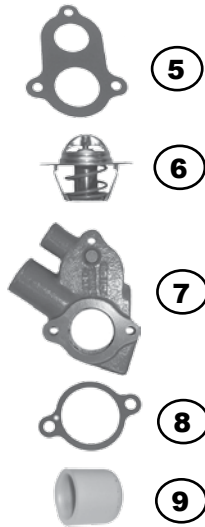
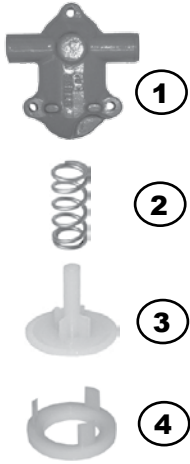

Ref#	Part#	Description:
1	CRU97556	Top housing
2	CRU96686	Spring
3	CRU96066	Valve
4	CRU96065	Seat
5	18-0875	Gasket
6	18-3551	Thermostat 143° RWC standard
*6	CRU97895	Thermostat 160° FWC optional
7	CRU97557	Lower housing
8	CRU96105	Gasket w/ ground
9	CRU96519	Rubber cap 1-3/4"
*9	OSC2228	Rubber cap 1-1/4"
10	CRU22366	Complete kit includes all except *6

CRUSADER (FWC) THERMOSTAT HOUSING

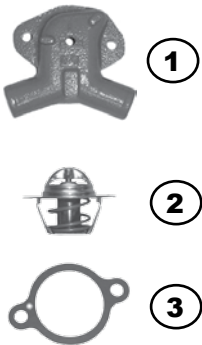

Ref#	Part#	Description:
1	CRU97851	Top cover
2	CRU96105	Gasket w/ ground
3	CRU97895	Thermostat 160°
4	CRU97452	Lower housing
5	CRU96105	Gasket w/ ground
6	MID28-2015	1/8" pipe plug for cover



FORD 302 & 351 (FWC) THERMOSTAT HOUSING

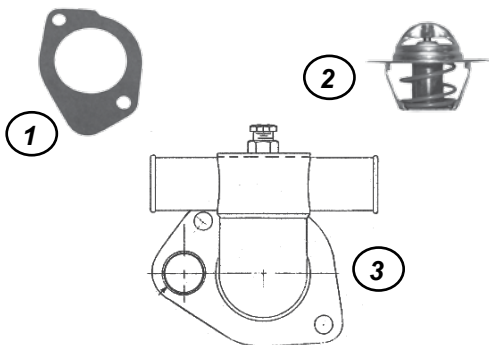

Ref#	Part#	Description:
1	18-0349	gasket, must drill hole for FWC applications
2	CRU97895	Thermostat 160°
3	BJM7556	Thermostat housing



OMC THERMOSTAT HOUSING

GM V6 & 8, (305 & 350), 1979 TO PRESENT

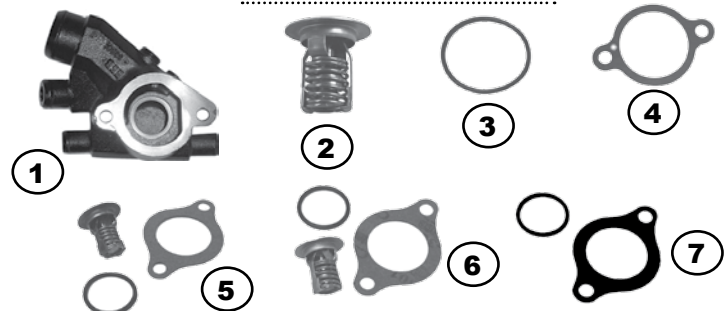

Ref#	Part#	Description:
1	3850360	Housing
2	18-3554	Thermostat 160°
3	18-7170	O-ring
4	CRU96105	Gasket w/ ground
5	18-3676	Kit includes 2, 3, & 4 (140°)
6	18-3677	Kit includes 2, 3, & 4 (160°)
7	FEL17630	Gasket & o-ring

MARINE THERMOSTAT HOUSINGS

OMC & GENERAL APPLICATION THERMOSTAT HOUSINGS



OMC THERMOSTAT HOUSING ASSEMBLIES

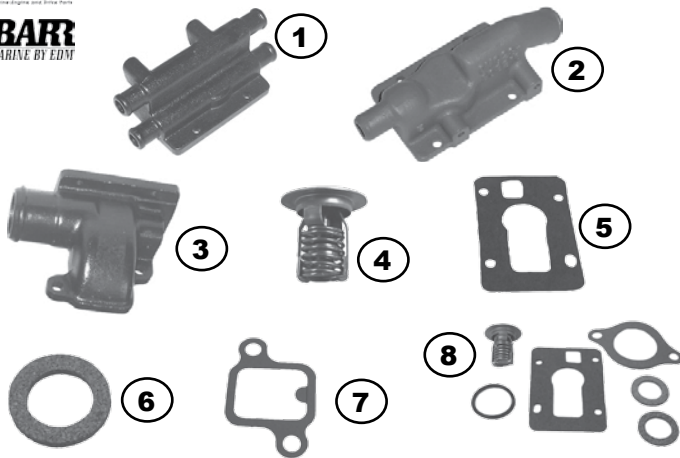

Ref#	Part#	Description:
1	OMC-29-314810	Upper housing 120hp
2	OMC-29-908216	Upper housing for 3.0L
3	OMC-29-910303	Lower housing
4	18-3554	Thermostat 160°
5	18-2858	Gasket
6	18-2947	Cork gasket
7	18-0164	Gasket
8	18-3653	Kit includes 4, 5, & 6

GENERAL APPLICATION (RWC) HOUSING ASSEMBLIES



GM Small Block V6 & 8
Chevrolet 229-400 cu.in. engines

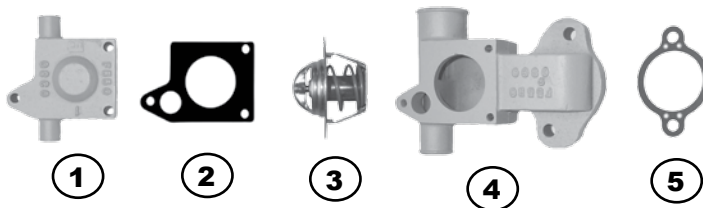

Ref#	Part#	Description:
2	OSCF55-G	Gasket, cover to base
3	18-3551	Thermostat 143°
5	18-2917	Gasket w/ ground
--	OSCCV55	Kit includes 1, 2, 3, & 4



GM Small Block & Big Block
for Dual Pump Cooling Systems

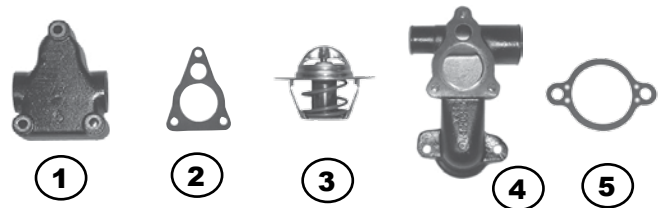

Ref#	Part#	Description:
2	OR-29-74-C	Gasket, cover to base
3	18-3551	Thermostat 143°
5	18-2917	Gasket w/ ground
--	CHV-29-80	Kit includes 1 thru 4, fits 4.3L V6 & 5.0/5.7L V8 engines
--	CHV-29-78	Kit includes 1 thru 4, fits 7.4L V* 454 cu.in. engines



Ford Small Block V8
302-351 cu.in. engines

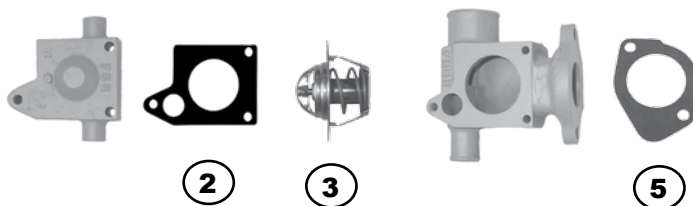

Ref#	Part#	Description:
--	OSCF55-G	NLA - Supersedes to FM-29-0083
2	OSCF55-G	Gasket, cover to base
3	18-3551	Thermostat 143°
5	18-0349	Gasket to block



Ford Small Block for
Dual Pump Cooling Systems

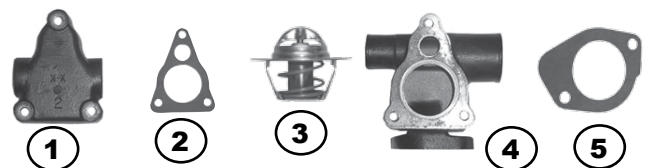

Ref#	Part#	Description:
2	OR-29-74-C	Gasket, cover to base
3	18-3551	Thermostat 143°
5	18-0349	Gasket to block
--	FM-29-0083	Kit includes 1 thru 4, fits 5.0 & 5.8L engines



MARINE THERMOSTAT HOUSINGS

PLEASURECRAFT, VOLVO, & SAN JUAN THERMOSTAT HOUSINGS



PLEASURE CRAFT THERMOSTAT HOUSING

fits (RWC) Ford 302 & 351 ci.in. engines



PLEASURE CRAFT THERMOSTAT HOUSING

fits (RWC) Small Block GM engines



Ref#	Part#	Description:
1	R025002	Top cover
2	RM0003	Gasket
3	18-3551	Thermostat 143°
4	18-3552	Thermostat 160°
5	R025001	Lower housing
6	18-0349	Lower housing gasket

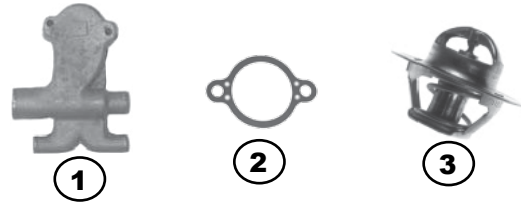

Ref#	Part#	Description:
1	R025014	Housing
2	18-2917	Gasket w/ ground
3	RP026002	Thermostat 160° (FWC)
*3	RP026002E	Thermostat 145° (RWC)



PLEASURE CRAFT THERMOSTAT HOUSING

fits (FWC) Small Block GM engines

VOLVO THERMOSTAT HOUSING



Ref#	Part#	Description:
1	RM0004	Gasket w/ ground
2	RP026001	Thermostat 170° (FWC)
3	18-0349	Gasket



Ref#	Part#	Description:
1	855485	Thermostat housing
2	416033	O-ring
3	RP026002	Thermostat 143°
4	855486	Lock ring
5	CRU96105	Lower gasket w/ ground
--	18-3662	Kit includes 2, 3, & 5



SAN JUAN GM (FWC) COPPER GENERAL APPLICATION THERMOSTAT HOUSING



Ref#	Part#	Description:
1	SANGM-HSG-180	Thermostat housing 180°
2	CRU97895	Thermostat 160° (FWC)
3	18-2917	Lower gasket w/ ground



Ref#	Part#	Description:
1	SANGM-HSG-V	Thermostat housing 90°
2	CRU97895	Thermostat 160° (FWC)
3	18-2917	Lower gasket w/ ground

MARINE THERMOSTAT HOUSINGS

CHRYSLER THERMOSTAT HOUSINGS



CHRYSLER V8 THERMOSTAT HOUSING

fits V8 LM 318/360 engines

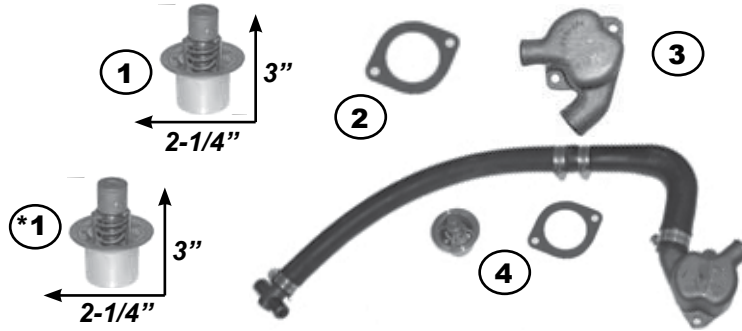

Ref#	Part#	Description:
1	CM-29-3675303	Thermostat 140°
*1	CM-29-4142522	Thermostat 160°
2	0050082	Housing gasket
3	2846215	Thermostat housing
4	2846215K	Kit includes 1, 2, & 3

CHRYSLER V8 THERMOSTAT HOUSING

for End Style Manifolds for all V8's w/ 2 pump cooling system

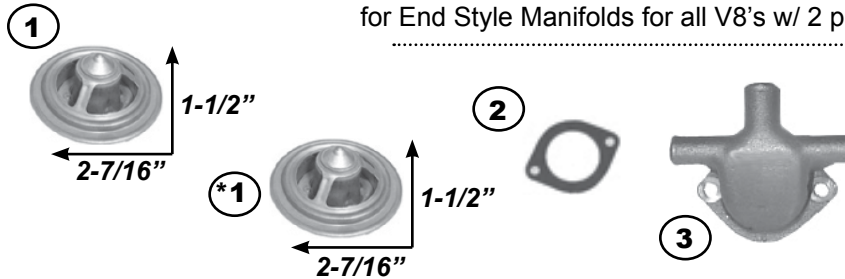

Ref#	Part#	Description:
1	3527765	Thermostat 140°
*1	3514177	Thermostat 160°
2	0050082	Housing gasket
3	3745360	Thermostat housing

CHRYSLER V8 THERMOSTAT HOUSING

for all V8 engines w/ 2 pump cooling central style manifold systems
Rochester carburetor used 1985 & newer

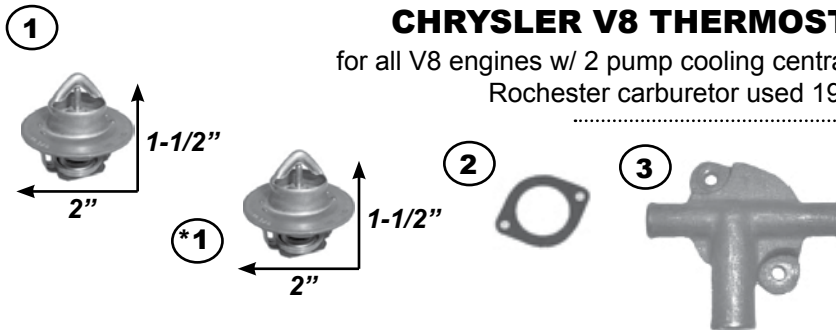

Ref#	Part#	Description:
1	4142885	Thermostat 140°
*1	CRU97895	Thermostat 160°
2	4142888	Housing gasket
3	4142661	Thermostat housing

CHRYSLER V8 (FWC) THERMOSTAT HOUSING

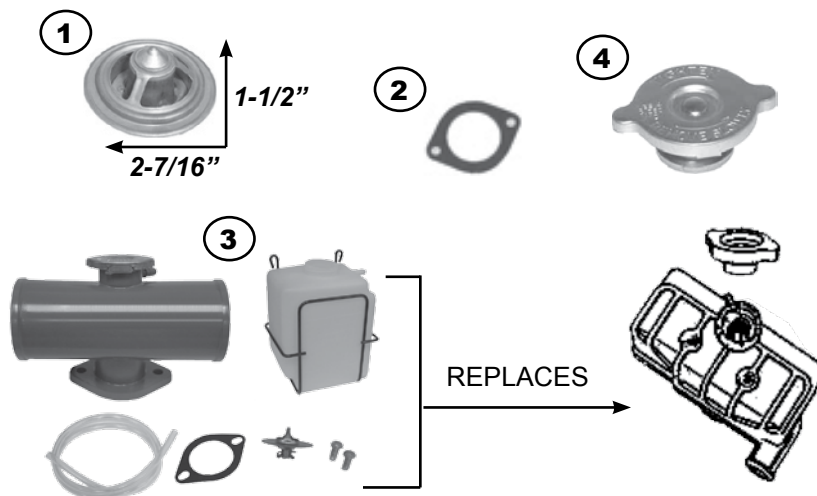

Ref#	Part#	Description:
1	3514177	Thermostat 160°
2	0050082	Gasket
3	SKPKP3011	Expansion tank kit, replaces square aluminum type tank
4	SEN0002	Cap, 14lbs.