

MARINE HEAT EXCHANGERS

CHRYSLER HEAT EXCHANGERS

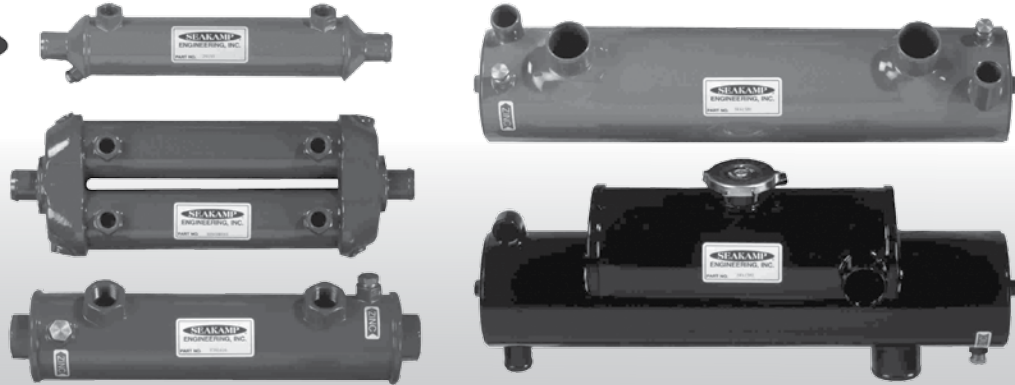

SEAKAMP



Seakamp Engineering Inc. was founded with three generations of experience in the manufacture of heat exchanger products, fresh water cooling systems, oil and transmission coolers for marine use. Our experience and engineering capabilities allow us to design systems that are the most efficient for their particular application.

Seakamp is committed to provide consistently high quality products. Time is of the essence whether it's a fishing boat in Alaska or a cruise boat in the Caribbean — you can't wait weeks for your product. **Lighthouse Marine Supply** maintains the largest inventory of replacement heat exchangers and oil coolers anywhere.

Lighthouse Marine Supply strives to make our product delivery second to none.

Request the "best" — contact our #1 seller, **Lighthouse Marine Supply**,
1-800-382-9335 or www.partman.com — "saving boaters weekends everywhere"

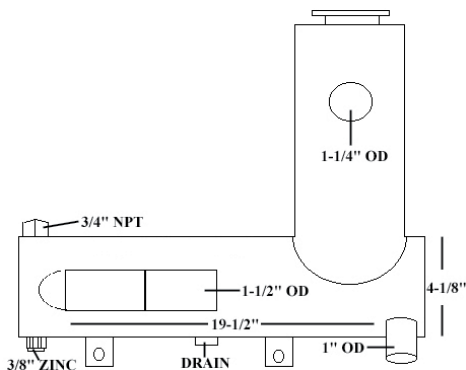
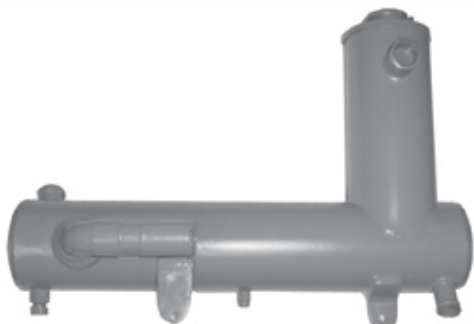

Part#
SKP2200-2250

Description:

Fits Chrysler 318/360, Rear mount, over the transmission, Cools engine block and manifolds, Direct replacement for Sen-Dure/Chrysler original exchanger



Part#
SKP4142598

Description:

Fits Chrysler 318/360. Side mount, under exhaust manifold, This unit has more cooling capacity than the original equipment, Cools engine block only, Direct replacement for Chrysler part #2847886



MARINE HEAT EXCHANGERS

CHRYSLER HEAT EXCHANGERS & ACCESSORIES

SEAKAMP

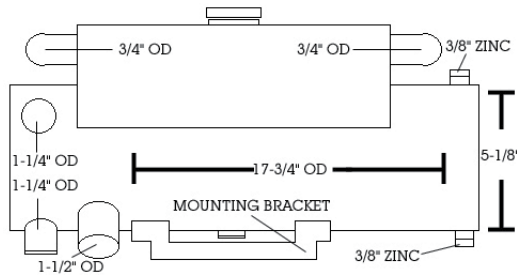

Part#
SKP3675141

Description:
Block only cooling for 360 CU.IN. Rear mount (OVER TRANSMISSION)", 5" Bundle height

CHRYSLER EXPANSION TANK



Part#
SKP3011

Description:
Chrysler 4142130 expansion tank replacement, New style for fresh water cooling block "ONLY", replaces original "rectangular" aluminum tank, made of copper 3" diam x 8"L x 6"H from intake manifold to filler cap, Hose fitting for 1-1/2", sits 1/2" high off intake manifold and 3-1/2" on center from tank throat. Complete with thermostat, gasket, hose, mounting bolts, bracket, & coolant recovery bottle

SEAKAMP



Part#
SKP97308

Description:
Crusader Bracket, Bell Housing Heat Exchanger Mounting Bracket for Crusader rear mounted (mounting over transmission) heat exchangers

HEAT EXCHANGER FILLER CAPS



SEN-DURE

Part#
SEN0001
SEN0002

Description:
7 lb. Cap, fits Chrysler & Crusader
14 lb. Cap. fits Mercruiser

SEN-DURE

HEAT EXCHANGER END CAPS



Ref#	Part#	Description:
A thru D	SEN5372	2-1/8" dia. kit
A thru D	SEN5373	2-3/4" dia. kit
A thru D	SEN5374	3-3/4" dia. kit
A thru D	SEN5375	4-3/4" dia. kit
C	SEN5068	Gum washer for bolt

SEAKAMP



Part#
SKPSK3111

Description:
Universal heat exchanger over flow tank, includes mounting hardware & 4' of overflow hose, replaces mercruiser 71587A10

D	SEN0493	2-1/8" rubber gasket only
D	SEN0332	2-3/4" rubber gasket only
D	SEN0259	3-3/4" rubber gasket only
D	SEN0396	4-3/4" rubber gasket only

MARINE HEAT EXCHANGERS

CRUSADER HEAT EXCHANGERS



SEAKAMP

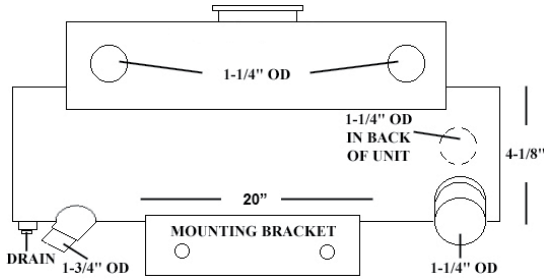

Part#
SKP97433

Description:

Crusader Small Block prior to 1985, rear mount over transmission (2 fittings on top of expansion tank), replaces Sendure #9364-1-5

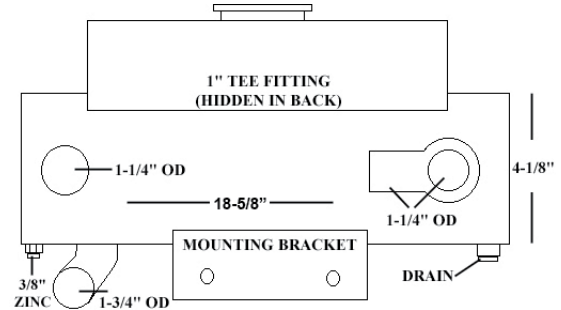

Part#
SKP97913

Description:

Crusader GM Small Block 1986 to 1992, rear mounted (OVER TRANSMISSION), replaces Sendure #9965-1-5

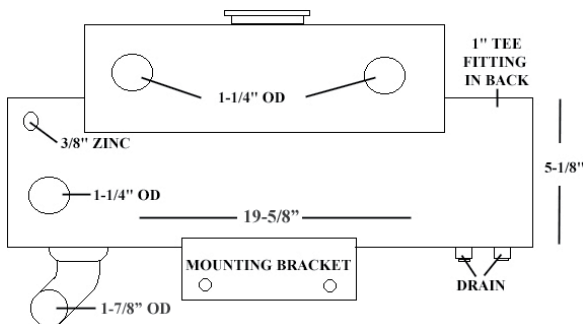
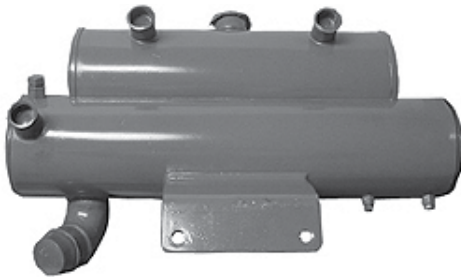

Part#
SKP97434

Description:

Crusader Big Block prior to 1985, rear mount over transmission (2 fittings on top of expansion tank), replaces Sendure #9365-1-5, this aftermarket heat exchanger has been upgraded to a 4-pass cooling system, which has more efficient cooling capacity than the original equipment heat exchanger, without altering the physical size of unit

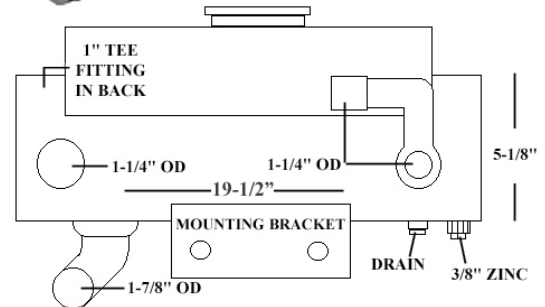
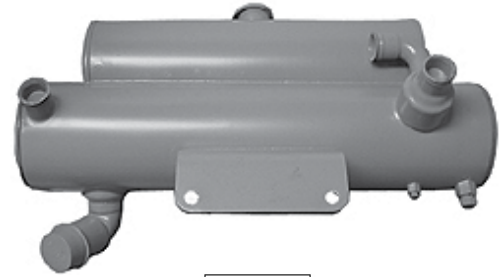

Part#
SKP97930

Description:

Crusader GM Big Block 1986 to 1992, rear mount (OVER TRANSMISSION), upgraded to more efficient 4 pass heat exchanger, replaces Sendure #9374-1-5, this aftermarket heat exchanger has been upgraded to a 4-pass cooling system, which has more efficient cooling capacity than the original equipment heat exchanger, without altering the physical size of unit



MARINE HEAT EXCHANGERS

CRUSADER & (CUMMINS DIESEL) HEAT EXCHANGERS

SEAKAMP

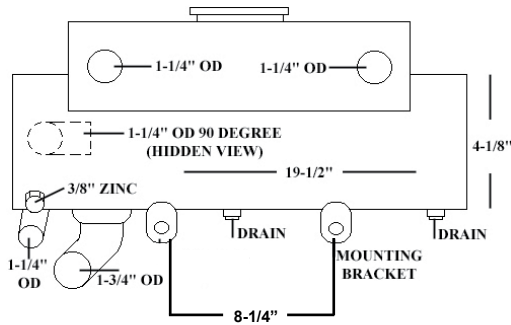

Part#
EXC1842

Description:
Crusader GM Small Block, Rear mount (over transmission), Replaces SEN-DURE #1842 Heat Exchanger, (2 fittings on top of expansion tank)

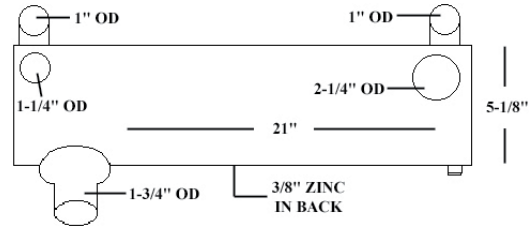

Part#
SKP98117

Description:
Crusader GM Big Block, Fits CM454HO serial #89465 & up, TB454XL serial #92882 & up, TB502XL serial #94268 & up and CM502XL serial #88765 & up, Rear Mounted (over the transmission)

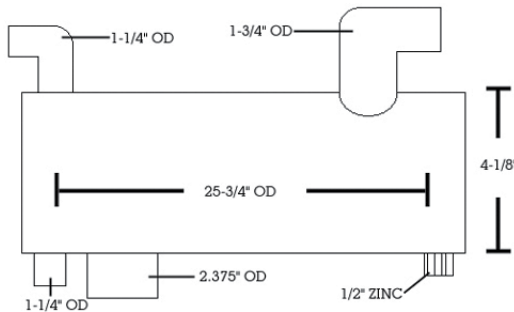

Made of cupro nickel for a longer lasting more durable unit. The bundles are also bonded into the baffles to create a stronger longer lasting core than the tubes that are only spot welded

Part#
SKP3910583-CN

Description:
Fits Cummins diesel model 6BT 210 Hp

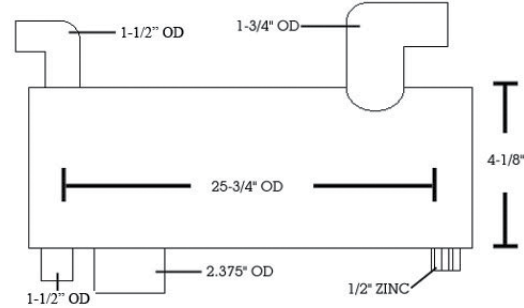

Made of cupro nickel for a longer lasting more durable unit. The bundles are also bonded into the baffles to create a stronger longer lasting core than the tubes that are only spot welded

Part#
SKP3914642-CN

Description:
Fits Cummins diesel model 6BT 260 Hp

MARINE HEAT EXCHANGERS

MERCUISER HEAT EXCHANGERS

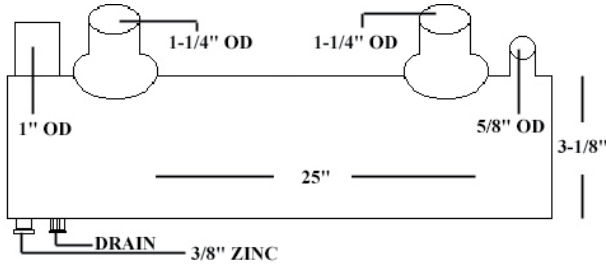

Part#

SAN77319

Description:

Fits Mercruiser 470, replaces Merc 77319A1 w/ 3" tank

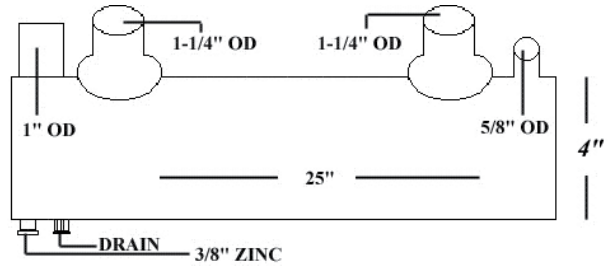

Part#

SKP41525

Description:

Merc 4" 470 replacement updates 3" heat exchanger to 4", requires 2 1098619A1 U bolts

SEAKAMP

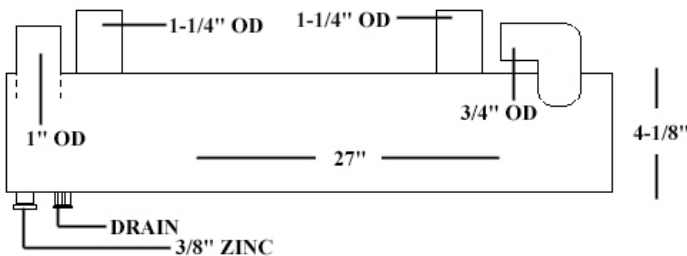
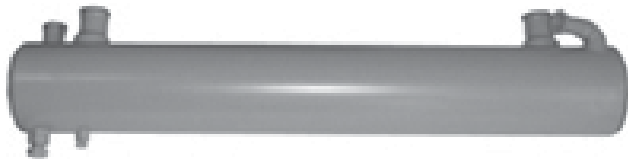

Part#

SAN99438

Description:

Fits Mercruiser 470, replaces Merc #99438A1 w/ 4" tank

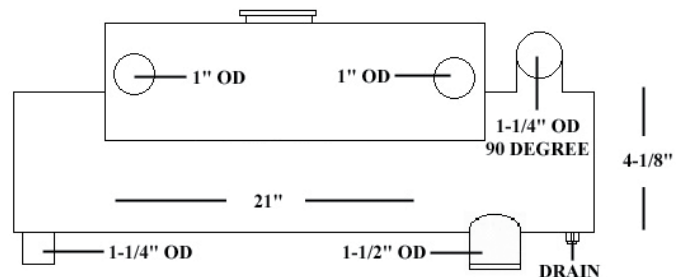
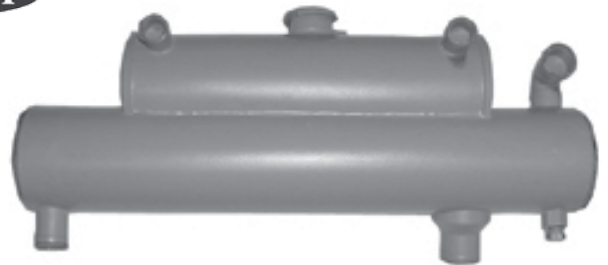

Part#

SKP91036

Description:

Fits Mercruiser Small Block Chevy 305 - 350 V8 blocks, Front mount (OVER WATER PUMP)



MARINE HEAT EXCHANGERS

MERCURISER HEAT EXCHANGERS

SEAKAMP

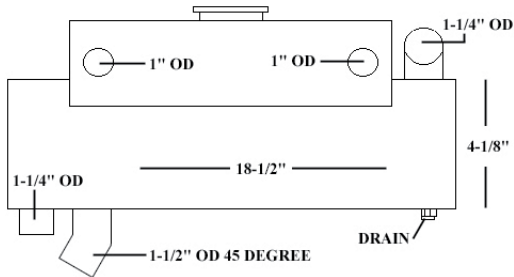

Part#
SKP78094

Description:
Fits Mercruiser Small Block Chevy 305 - 350 V8 blocks,
Rear mount (OVER TRANSMISSION)

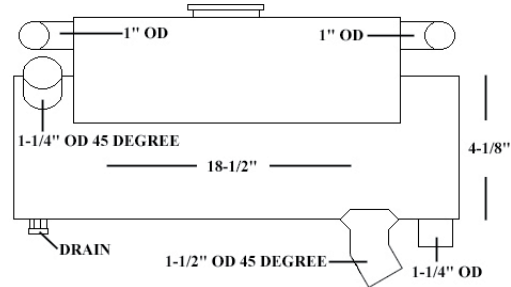

Part#
SKP74643

Description:
Fits Mercruiser Small Block Chevy 305 - 350 V8 blocks,
Front mount (OVER WATER PUMP)

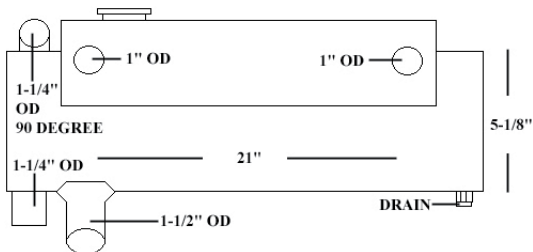

Part#
SKP44446

Description:
Fits GM Mercruiser big block Chevy 454 , Rear mount
(OVER TRANSMISSION)

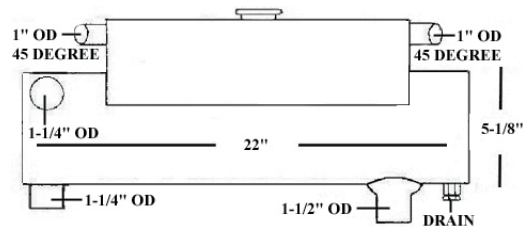

Part#
SKP63107

Description:
Fits GM Mercruiser Big Block Chevy 454 with log style
exhaust manifolds, Front mount (OVER WATER PUMP)

MARINE HEAT EXCHANGERS

MERCUISER, PLEASURE CRAFT, & VOLVO HEAT EXCHANGERS



SEAKAMP

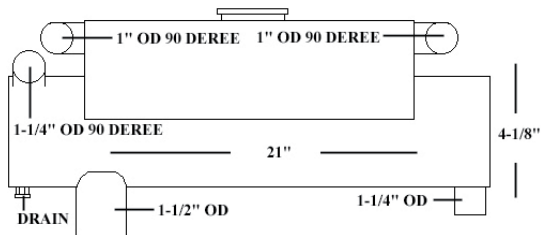

Part#

SKP79607

Description:

Fits GM Mercruiser Big Block Chevy 454 with log style exhaust manifolds, Rear mount (OVER TRANSMISSION)

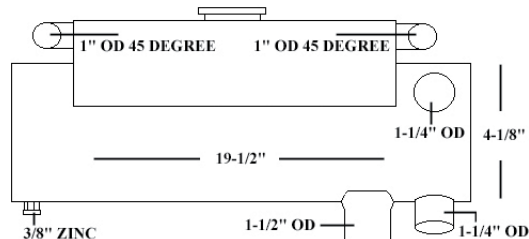

Part#

SKP62472

Description:

Fits Mercruiser Ford small 302 - 351 blocks, Front mount (OVER WATER PUMP)

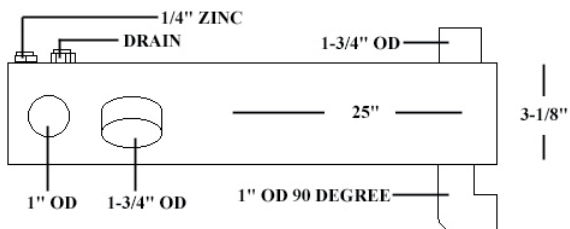

Part#

SKP147008

Description:

Fits PCM small block 302 - 351 Fords, This is a direct replacement for all PCM side mount heat exchangers, this is a triple pass unit as opposed to the single pass OEM model

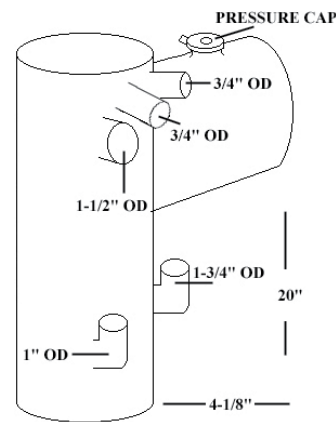

Part#

SKP3350

Description:

Fits GM Volvo small 305 - 350 blocks, Front mount, "L shaped" Block only